



# Complexity of planar signed graph homomorphisms to cycles<sup>☆</sup>

François Dross<sup>a,b,1</sup>, Florent Foucaud<sup>c,d,\*</sup>, Valia Mitsou<sup>e</sup>, Pascal Ochem<sup>f</sup>,  
Théo Pierron<sup>g,c,2,3</sup>

<sup>a</sup> Institute of Informatics, University of Warsaw, Poland

<sup>b</sup> I3S, Université Nice Sophia Antipolis, France

<sup>c</sup> Univ. Bordeaux, Bordeaux INP, CNRS, LaBRI, UMR5800, France

<sup>d</sup> Univ. Orléans, INSA Centre Val de Loire, LIFO EA 4022, F-45067 Orléans Cedex 2, France

<sup>e</sup> IRIF, Université de Paris, France

<sup>f</sup> LIRMM, Université de Montpellier, CNRS, Montpellier, France

<sup>g</sup> Faculty of Informatics, Masaryk University, Botanická 68A, 602 00 Brno, Czech Republic

## ARTICLE INFO

### Article history:

Received 9 July 2019

Received in revised form 6 March 2020

Accepted 14 March 2020

Available online 8 April 2020

### Keywords:

Signed graph

Edge-coloured graph

Graph homomorphism

Planar graph

## ABSTRACT

We study homomorphism problems of signed graphs from a computational point of view. A signed graph is an undirected graph where each edge is given a sign, positive or negative. An important concept when studying signed graphs is the operation of switching at a vertex, which is to change the sign of each incident edge. A homomorphism of a graph is a vertex-mapping that preserves the adjacencies; in the case of signed graphs, we also preserve the edge-signs. Special homomorphisms of signed graphs, called  $s$ -homomorphisms, have been studied. In an  $s$ -homomorphism, we allow, before the mapping, to perform any number of switchings on the source signed graph. The concept of  $s$ -homomorphisms has been extensively studied, and a full complexity classification (polynomial or NP-complete) for  $s$ -homomorphism to a fixed target signed graph has recently been obtained. Nevertheless, such a dichotomy is not known when we restrict the input graph to be planar, not even for non-signed graph homomorphisms.

We show that deciding whether a (non-signed) planar graph admits a homomorphism to the square  $C_4^2$  of a cycle with  $t \geq 6$ , or to the circular clique  $K_{4t/(2t-1)}$  with  $t \geq 2$ , are NP-complete problems. We use these results to show that deciding whether a planar signed graph admits an  $s$ -homomorphism to an unbalanced even cycle is NP-complete. (A cycle is unbalanced if it has an odd number of negative edges). We deduce a complete complexity dichotomy for the planar  $s$ -homomorphism problem with any signed cycle as a target.

We also study further restrictions involving the maximum degree and the girth of the input signed graph. We prove that planar  $s$ -homomorphism problems to signed cycles remain NP-complete even for inputs of maximum degree 3 (except for the case of unbalanced 4-cycles, for which we show this for maximum degree 4). We also show that for a given integer  $g$ , the problem for signed bipartite planar inputs of girth  $g$  is either trivial or NP-complete.

© 2020 Published by Elsevier B.V.

<sup>☆</sup> This work is supported by the ANR, France project HOSIGRA (ANR-17-CE40-0022).

\* Corresponding author at: Univ. Orléans, INSA Centre Val de Loire, LIFO EA 4022, F-45067 Orléans Cedex 2, France.

E-mail addresses: [francois.dross@googlemail.com](mailto:francois.dross@googlemail.com) (F. Dross), [florent.foucaud@gmail.fr](mailto:florent.foucaud@gmail.fr) (F. Foucaud), [vmitsou@liris.cnrs.fr](mailto:vmitsou@liris.cnrs.fr) (V. Mitsou), [pascal.ochem@lirmm.fr](mailto:pascal.ochem@lirmm.fr) (P. Ochem), [pierron@fi.muni.cz](mailto:pierron@fi.muni.cz) (T. Pierron).

<sup>1</sup> This author was partially supported by the European Research Council (ERC) under the European Union's Horizon 2020 research and innovation programme, Grant Agreement 714704.

<sup>2</sup> This author is partially supported by the IFCAM, India project "Applications of graph homomorphisms" (MA/IFCAM/18/39).

<sup>3</sup> This research was supported by the MUNI Award in Science and Humanities of the Grant Agency of Masaryk university, Czechia.

## 1. Introduction

In this paper, we study the computational complexity of graph and signed graph homomorphism problems. Our main focus is the case where the inputs are planar and the targets are cycles (but we also consider other cases). Homomorphisms are structure-preserving mappings between discrete structures; this type of problems is very general and models many combinatorial problems. Consequently, the study of the algorithmic properties of homomorphism problems is a rich area of research that has gained a lot of attention. We refer to the book [27] as a reference on graph homomorphism problems.

An edge-coloured graph is a graph with several types of (undirected) edges: each type corresponds to a colour. Given two edge-coloured graphs  $G$  and  $H$ , a *homomorphism* of  $G$  to  $H$  is a vertex-mapping  $f$  of  $V(G)$  to  $V(H)$  that preserves adjacencies and edge-colours, that is, if  $x$  and  $y$  are adjacent via a  $c$ -coloured edge in  $G$ , then  $f(x)$  and  $f(y)$  must be adjacent via a  $c$ -coloured edge in  $H$  as well. When such a homomorphism exists, we write  $G \rightarrow H$ . This concept is studied for example in [1,5,24,34,41]. In this language, standard undirected graphs can simply be seen as 1-edge-coloured graphs. Signed graphs are a special type of 2-edge-coloured graphs whose edge-colours are signs: positive and negative. In this paper, we will consider two types of objects: standard undirected graphs (that will simply be called (*1-edge-coloured graphs*)), and signed graphs.

*Computational homomorphism problems.* The most fundamental class of algorithmic homomorphism problems is the following one (where  $H$  is any fixed edge-coloured graph):

$\text{HOM}(H)$

Instance: An (edge-coloured) graph  $G$ .

Question: Does  $G$  admit a homomorphism to  $H$ ?

Problem  $\text{HOM}(H)$  has been studied for decades. For example, consider 1-edge-coloured graphs, and denote the 3-vertex complete graph by  $K_3$ . Then,  $\text{HOM}(K_3)$  is the classic 3-COLOURING problem, shown NP-complete by Karp [29]. (More generally, a proper  $t$ -colouring of a graph  $G$  is a homomorphism to the complete graph  $K_t$ .)  $\text{HOM}(H)$  for edge-coloured graphs is studied for example in [5–7,9,36].

$\text{HOM}(H)$  is also studied under the name of CONSTRAINT SATISFACTION PROBLEM (CSP), see for example [15]. In this setting, edge-coloured graphs are seen as structures coming with a number of symmetric binary relations (one for each edge-colour). In the context of CSPs, one also considers discrete relational structures that may have relations of arbitrary arities. The celebrated *Dichotomy Conjecture* of Feder and Vardi [15] and the subsequent work aims at classifying the complexity of general CSP problems. While the conjecture was recently solved in [11,50] (independently) using the tools and language of *universal algebra*, this algebraic formulation does not always provide simple explicit descriptions of the dichotomy. Thus, obtaining explicit dichotomy classifications for relevant special cases is still of major interest.

When studying  $\text{HOM}(H)$ , we may always restrict ourselves to edge-coloured graphs  $H$  that are *cores*:  $H$  is a *core* if it does not have any homomorphism to a proper subgraph of itself (in other words, all of its endomorphisms are automorphisms). Moreover, the *core* of an edge-coloured graph  $H$ , noted  $\text{core}(H)$ , is the smallest subgraph of  $H$  that is a core. It is well-known that the core of an edge-coloured graph is unique (up to isomorphism). It is not difficult to observe that the complexity of  $\text{HOM}(H)$  is the same as the one of  $\text{HOM}(\text{core}(H))$ . For more details on these notions see the book [27].

One of the most fundamental results in the area of CSP dichotomies is the one obtained for 1-edge-coloured graphs by Hell and Nešetřil. They proved in [26] that if the core of an undirected graph  $H$  has at least two edges,  $\text{HOM}(H)$  is NP-complete, and polynomial-time otherwise. (Note that the latter condition equates to say that  $H$  is bipartite or has a loop, a property that is easily testable.) One may ask the following natural question: what is the behaviour of the above dichotomy for specific restrictions of the input graphs?

*Planar instances.* Colouring and homomorphism problems are studied extensively for the class of planar graphs. One consequence of the Four Colour Theorem (that any planar graph is properly 4-colourable) is that, contrarily to the general case,  $\text{HOM}(K_4)$  is trivially polynomial-time solvable for planar instances. In this paper, we will study the following restriction of  $\text{HOM}(H)$ :

$\text{PLANAR HOM}(H)$

Instance: A planar (edge-coloured) graph  $G$ .

Question: Does  $G$  admit a homomorphism to  $H$ ?

A complexity dichotomy for  $\text{PLANAR HOM}(H)$  in the case of 1-edge-coloured graphs, if it exists, is probably not as easy to describe as the Hell–Nešetřil dichotomy for  $\text{HOM}(H)$ .  $\text{PLANAR HOM}(H)$  is known to be NP-complete for  $H = K_3$  [19], but, as mentioned before, it is trivially polynomial-time when  $H$  contains a 4-clique. There are other non-trivial examples that are polynomial-time. For example, consider the Clebsch graph  $C_{16}$ , a remarkable triangle-free graph of order 16. It follows from [21,37] that every triangle-free planar graph has a homomorphism to  $C_{16}$ . Since  $C_{16}$  itself has no triangle, a planar graph maps to  $C_{16}$  if and only if it is triangle-free, and thus  $\text{PLANAR HOM}(C_{16})$  is polynomial-time solvable. Infinitely many such examples are known, see [25,40].

$\text{PLANAR HOM}(H)$  for 1-edge-coloured graphs was studied more extensively in [25,33], where it was independently proved to be NP-complete when  $H$  is any odd cycle  $C_{2k+1}$ , via two different techniques. It is also proved in [33] that  $\text{PLANAR HOM}(H)$  is NP-complete whenever  $H$  is subcubic and has girth 5.  $\text{PLANAR HOM}(H)$  is also proved NP-complete in [25] when  $H$  is an odd wheel, or the Penny graph.

*Further instance restrictions.* The difficulty of classifying the complexity of  $\text{PLANAR HOM}(H)$  makes it meaningful to further refine the pool of graph instances to be examined. For example, restrictions on the maximum degree are studied in [18,42]. In [42], it is proved that for every undirected non-bipartite graph  $H$ , there is an integer  $b(H)$  such that  $\text{HOM}(H)$  is NP-complete for graphs of maximum degree  $b(H)$ . The value of  $b(H)$  can be arbitrarily large, but for many graphs  $H$ ,  $b(H) = 3$  [42]. In particular, it is proved in [18] that for all  $k \geq 1$ ,  $b(C_{2k+1}) = 3$ , that is,  $\text{HOM}(C_{2k+1})$  is NP-complete for subcubic graphs. In fact, the result from [18] (combined with [25,33]) also implies that  $\text{PLANAR HOM}(C_{2k+1})$  is NP-complete for subcubic graphs.

Other restrictions are on the *girth* of the input graph, that is, the smallest length of a cycle. It is known that for any  $k \geq 1$ , there is an integer  $g = g(k)$  such that all planar graphs of girth at least  $g$  admit a homomorphism to  $C_{2k+1}$  [17]. A restriction to planar graphs of a conjecture of Jaeger [28] implies that  $g(k) = 4k$ , and it is known that  $4k \leq g(k) \leq (20k - 2)/3$  [4]. In [13], it is proved that for every fixed  $k \geq 2$  and  $g \geq 3$ , either every planar graph of girth at least  $g$  maps to  $C_{2k+1}$ , or  $\text{PLANAR HOM}(C_{2k+1})$  is NP-complete for such graphs. Other examples of this type of “hypothetical complexity” theorems exist in other contexts, see for example [14,31].

*Signed graphs and switching homomorphisms.* Signed graphs are special types of 2-edge-coloured graphs, whose edge-colours represent signs: positive and negative. Formally, a signed graph is a pair  $(G, \sigma)$ , where  $G$  is the underlying graph (the graph containing both the positive and the negative edges) and  $\sigma : E(G) \rightarrow \{-1, +1\}$  is the sign function that describes the edge-signs. Signed graphs were studied as early as the 1930s in the first book on graph theory by König [32]. They were rediscovered in the 1950s by Harary [23], who introduced the name *signed graph* and applied them to the area of social psychology. The concept was later developed by Zaslavsky in [47] and numerous subsequent papers [44–48] and has become an important part of combinatorics, with many connections to deep results and conjectures. See [43] for a dynamic bibliography on the topic.

Zaslavsky [47] introduced the *switching* operation: given a signed graph  $G$  and a vertex  $v$ , to switch at  $v$  is to change the sign of all edges incident to  $v$  (this can be seen as multiplying their signs by  $-1$ ). We say that two signed graphs  $G$  and  $G'$  are *switching-equivalent* if  $G'$  can be obtained from  $G$  by any sequence of switchings. Note that one can test switching-equivalence in polynomial time (on labelled graphs), see [7,47].

The switching operation turns out to be important in the context of graph minors, and it relates to some outstanding problems in graph theory, see [22,38,39] for details. In this context, Guenin introduced in [22] a special kind of homomorphisms of signed graphs, whose theory was later developed in [38,39]. Following the terminology in [7], we define an *s-homomorphism* of a signed graph  $G$  to a signed graph  $H$  as a vertex-mapping  $f$  from  $V(G)$  to  $V(H)$  such that there exists a signed graph  $G'$  that is switching-equivalent to  $G$ , and  $f$  is a classic edge-coloured graph homomorphism of  $G'$  to  $H$ . (Note that additionally one may allow switching at  $H$ ; this does not change the problem, and we will generally not do so, but we can fix a convenient switching-equivalent sign function of  $H$  and stick to it.) When an *s-homomorphism* exists, we note  $G \xrightarrow{s} H$ .

Similarly to edge-coloured graph homomorphism, we say that a signed graph  $G$  is an *s-core* if  $G$  admits no *s-homomorphism* to a proper signed subgraph of itself, and *the s-core* of  $G$  is the smallest subgraph of  $G$  that is an *s-core* (it is unique up to *s-isomorphism* and switching [39]).

We next define the decision problem that corresponds to *s-homomorphisms* (with  $H$  a fixed signed graph).

**s-HOM( $H$ )**

Instance: A signed graph  $G$ .

Question: Does  $G$  admit an *s-homomorphism* to  $H$ ?

Note that for two switching-equivalent signed graphs  $H$  and  $H'$ , the definition of an *s-homomorphism* implies that  $\text{s-HOM}(H)$  and  $\text{s-HOM}(H')$  have the same complexity.

Extending the Hell–Nešetřil dichotomy [26] for  $\text{HOM}(H)$  for 1-edge-coloured graph problems, a complexity dichotomy for  $\text{s-HOM}(H)$  problems was proved in the papers [7,10]. The authors showed that if the *s-core* of a signed graph  $H$  has at least three edges, then  $\text{s-HOM}(H)$  is NP-complete; it is polynomial-time otherwise. On the other hand, it was shown in [7] that a similar dichotomy for  $\text{HOM}(H)$  problems for signed graphs (that is, 2-edge-coloured graphs and no switching allowed), is as difficult to obtain as the one for general CSPs. This indicates that it probably cannot be stated in simple graph-theoretic terms.

The authors of [7] asked what is the complexity of  $\text{s-HOM}(H)$  problems when the input is planar. Let us define the corresponding analogue of  $\text{PLANAR HOM}(H)$ .

**PLANAR s-HOM( $H$ )**

Instance: A planar signed graph  $G$ .

Question: Does  $G$  admit an *s-homomorphism* to  $H$ ?

An interesting case is the one when  $H = (C_k, \sigma)$  is a cycle ( $k \geq 3$ ). If  $H$  is switching-equivalent either to an all-positive  $C_k$ , or to an all-negative  $C_k$ , then the complexity of  $\text{s-HOM}(H)$  and  $\text{PLANAR s-HOM}(H)$  are the same as the ones of  $\text{HOM}(C_k)$  and  $\text{PLANAR HOM}(C_k)$ , respectively [7]. When  $k$  is odd, one of these two cases holds, and thus by the results of [25,33], in that case  $\text{PLANAR s-HOM}(H)$  is NP-complete.

To state the situation when  $k$  is even, it is convenient to introduce the notion of *balance*: a signed graph is *balanced* if every cycle contains an even number of negative edges. This central notion is already presented in the work of König [32] but was theorized by Harary [23].

If  $k = 2t$  is even and  $H = (C_k, \sigma)$  is balanced,  $H$  is switching-equivalent to a positive 2-vertex complete graph and thus  $\text{PLANAR s-HOM}(H)$  is polynomial-time. When  $H$  is unbalanced, by switching  $H$  if necessary, we may assume that  $H$  has a unique negative edge and denote this signed graph by  $UC_{2t}$ . Then,  $\text{s-HOM}(UC_{2t})$  has been proved to be NP-complete [7,16], but the complexity of  $\text{PLANAR s-HOM}(UC_{2t})$  is not known. We settle this question in this paper.

We point out that homomorphisms of non-signed graphs to odd cycles are an important topic in the theory of homomorphisms and circular colourings. Odd cycles are among the simplest non-trivial graphs (with respect to homomorphisms) and are fundamental in the study of graph colourings. Several well-studied open questions and conjectures involving homomorphisms to odd cycles exist in the area, such as Jaeger's conjecture and others (see [4,13] for more details). For s-homomorphisms of bipartite signed graphs, unbalanced even cycles play a similar role as odd cycles for homomorphisms of non-signed graphs. Here also, certain interesting conjectures and theorems are stated, see [12] for a recent study. This motivates the study of the complexity of s-homomorphisms to cycles.

*Our results.* Our main goal is to prove that  $\text{PLANAR s-HOM}(UC_{2k})$  is NP-complete whenever  $k \geq 2$ . As a first step, in Section 3, we study non-signed graphs. We prove that  $\text{PLANAR HOM}(H)$  is NP-complete when  $H$  is the square of a cycle; in turn, this is used to prove that  $\text{PLANAR HOM}(H)$  is NP-complete when  $H$  is a cubic circular clique. In Section 4, we use these results to prove that  $\text{PLANAR s-HOM}(UC_{2k})$  is NP-complete whenever  $k \geq 3$ . In Section 5, using a different technique, we prove that the case  $k = 2$  is also NP-complete. In Section 6, we show that for every integer  $k \geq 1$  and even integer  $g \geq 2$ , either every planar bipartite signed graph of girth  $g$  admits a homomorphism to  $UC_{2k}$ , or  $\text{PLANAR s-HOM}(UC_{2k})$  is NP-complete for planar bipartite inputs of girth  $g$ . In Section 7, we show that the results of Section 4 also apply to subcubic input signed graphs (except for  $UC_4$ , for which this holds for maximum degree 4). We first start with some preliminary considerations in Section 2.

## 2. Preliminaries

This section gathers some preliminary considerations.

### 2.1. Some definitions

Given a graph  $G$ , the *square* of  $G$ , denoted  $G^2$ , is the graph obtained from  $G$  by adding edges between all vertices at distance 2.

Given two integers  $p \geq 2$  and  $q \geq 1$  with  $\text{gcd}(p, q) = 1$ , the *circular clique*  $K_{p/q}$  is the graph on vertex set  $\{k_0, \dots, k_{p-1}\}$  with  $k_i$  adjacent to  $k_j$  if and only if  $q \leq |i - j| \leq p - q$ . Circular cliques are defined in the context of circular chromatic number, see for example [49].

### 2.2. Switching graphs

We now describe a construction that is important when studying s-homomorphisms.

**Definition 2.1.** Let  $G$  be a signed graph. The *switching graph* of  $G$  is a signed graph denoted  $\rho(G)$  and constructed as follows.

- (i) For each vertex  $u$  in  $V(G)$  we have two vertices  $u_0$  and  $u_1$  in  $\rho(G)$ .
- (ii) For each edge  $e$  between  $u$  and  $v$  in  $G$ , we have four edges between  $u_i$  and  $v_j$  ( $i, j \in \{0, 1\}$ ) in  $\rho(G)$ , with the edges between  $u_i$  and  $v_j$  having the same sign as  $e$  and the edges between  $u_i$  and  $v_{1-j}$  having the opposite sign ( $i \in \{0, 1\}$ ).

See Fig. 1 for examples of signed graphs and their switching graphs. (In all our figures, dashed edges are red/negative, while full edges are blue/positive). The notion of switching graph was defined by Brewster and Graves in [8] in a more general setting related to permutations (they called it *permutation graph*). A related construction was used in [30] in the context of digraphs. The construction is also used in [41] under the name *antitwinned graph*. Switching graphs play a key role in the study of signed graph homomorphisms, indeed they have several useful properties. One such property is that the switching graph of a signed graph contains, as subgraphs, all switching-equivalent signed graphs. Additionally, the following proposition allows us to study s-homomorphisms in the realm of standard homomorphisms.

**Proposition 2.2** (Proposition 2.5 in [7]). Let  $G$  and  $H$  be two signed graphs. Then,  $G \xrightarrow{s} H$  if and only if  $G \rightarrow \rho(H)$ .

Thus, we obtain the following corollary.

**Corollary 2.3.** Let  $H$  be a signed graph. Then,  $\text{s-HOM}(H)$  and  $\text{PLANAR s-HOM}(H)$  have the same complexity as  $\text{HOM}(\rho(H))$  and  $\text{PLANAR HOM}(\rho(H))$ , respectively.

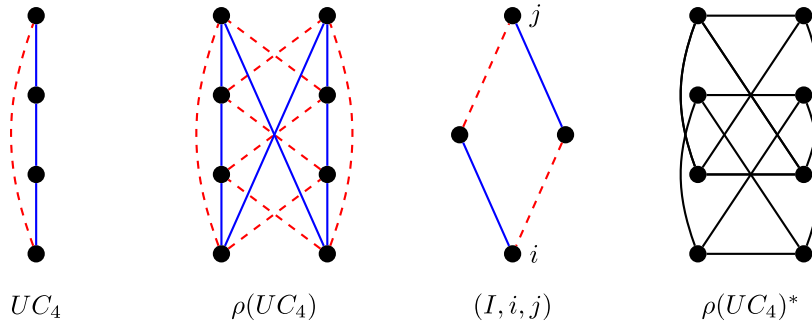

Fig. 1. The unbalanced cycle  $UC_4$ , its switching graph  $\rho(UC_4)$ , the indicator  $(I, i, j)$  and its resulting undirected graph  $\rho(UC_4)^*$ .

2.3. The indicator construction

We recall the *indicator construction*, one of the main tools used in the proof of the Hell–Nešetřil dichotomy for  $\text{HOM}(H)$  in [26].

**Definition 2.4.** Let  $H$  be a signed graph. An *indicator*  $(I, i, j)$ , is a signed graph  $I$  with two distinguished vertices  $i$  and  $j$  such that  $I$  admits an automorphism mapping  $i$  to  $j$  and vice-versa. The *result of the indicator*  $(I, i, j)$  applied to  $H$  is an undirected graph denoted  $H^*$  and defined as follows.

- (i)  $V(H^*) = V(H)$
- (ii) There is an edge from  $u$  to  $v$  in  $H^*$  if there is a homomorphism of  $I \rightarrow H$  such that  $i \mapsto u$  and  $j \mapsto v$ .

We say that  $(I, i, j)$  *preserves planarity* if, given a planar undirected graph  $G$ , replacing each edge  $uv$  with a copy of  $(I, i, j)$  by identifying  $u$  with  $i$  and  $v$  with  $j$ , we obtain a planar signed graph.

The following result shows how we can use this tool.

**Theorem 2.5** (Hell and Nešetřil [26]). *Let  $H$  be a signed graph,  $(I, i, j)$ , an indicator and  $H^*$ , the undirected graph resulting from  $(I, i, j)$  applied to  $H$ . Then,  $\text{HOM}(H^*)$  admits a polynomial-time reduction to  $\text{HOM}(H)$ .*

*Moreover, if the indicator construction preserves planarity, then  $\text{PLANAR HOM}(H^*)$  admits a polynomial-time reduction to  $\text{PLANAR HOM}(H)$ .*

**Proof.** We sketch the proof. Given an input graph  $G$  of  $\text{HOM}(H^*)$ , we construct a signed graph  $f(G)$  by replacing each edge  $uv$  in  $G$  by a copy of  $(I, i, j)$  by identifying  $u$  with  $i$  and  $v$  with  $j$ . (If  $G$  is planar and  $(I, i, j)$  preserves planarity, then  $f(G)$  is also planar.) Now it is not difficult to show that  $G \rightarrow H^*$  if and only if  $f(G) \rightarrow H$ .  $\square$

As an example, consider the signed graph  $UC_4$  and its switching graph  $\rho(UC_4)$ . Let  $I$  be the 4-cycle with two parallel negative and two parallel positive edges, where  $i$  and  $j$  are two non-adjacent vertices  $i$  and  $j$ . The result  $\rho(UC_4)^*$  of  $(I, i, j)$  applied to  $\rho(UC_4)$  is shown in Fig. 1: it consists of two disjoint copies of  $K_4$  (thus its core is  $K_4$ ). By Theorem 2.5 and Corollary 2.3, this implies that  $\text{HOM}(\rho(UC_4))$  and  $s\text{-HOM}(UC_4)$  are NP-complete, by a reduction from  $\text{HOM}(K_4)$ . Note that the application of  $(I, i, j)$  preserves planarity; however it is useless to reduce  $\text{PLANAR HOM}(K_4)$  to  $\text{PLANAR HOM}(UC_4)$  since the former is polynomial-time solvable by the Four Colour Theorem. We thus handle this case with an ad-hoc proof in Section 5.

3. Some NP-complete (non-signed) PLANAR HOM(H) cases

In this section, we prove that  $\text{PLANAR HOM}(H)$  is NP-complete for two special cases which were not known to be NP-complete.

3.1. Squares of cycles

We first deal with the case where  $H$  is the square  $C_t^2$  of a cycle  $C_t$ . The proof is inspired by the proof that  $\text{PLANAR HOM}(C_{2k+1})$  is NP-complete from [33]. Note that,  $C_4^2 = K_4$  and  $C_5^2 = K_5$ , and thus by the Four Colour Theorem  $\text{PLANAR HOM}(C_t^2)$  is polynomial-time solvable when  $t = 4, 5$ .

**Theorem 3.1.** *For every  $t \geq 6$ ,  $\text{PLANAR HOM}(C_t^2)$  is NP-complete.*

**Proof.** We will reduce from PLANAR HOM( $C_{2k+1}$ ) for suitable values of  $k$ , which is NP-complete whenever  $k \geq 1$  [33]. The proof is split into different cases depending on the values of  $t \pmod 3$  and  $t \pmod 4$ .

If  $t \equiv 0 \pmod 3$ , then the core of  $C_t^2$  is  $K_3$  and we are done since PLANAR HOM( $K_3$ ) is NP-complete.

Otherwise,  $C_t^2$  is a core. Let  $v_0, \dots, v_{t-1}$  be its vertices and  $v_i v_{i+1}$  and  $v_i v_{i+2}$  be its edges (indices are taken modulo  $t$ ).

If  $t \equiv 2 \pmod 4$ , then  $C_t^2$  is planar, the set of edges  $v_i v_{i+1}$  induces a cycle of length  $t$ , and the set of edges  $v_i v_{i+2}$  induces two disjoint odd cycles of length  $t/2$ . We reduce PLANAR HOM( $C_{t/2}$ ) to PLANAR HOM( $C_t^2$ ). Let  $G$  be a planar graph and let  $G'$  be the planar graph obtained from  $G$  as follows. For every edge  $e$  of  $G$ , we add a copy of  $C_t^2$  and we identify the edge  $v_0 v_2$  of this copy of  $C_t^2$  with  $e$ . One can see that  $G$  maps to  $C_{t/2}$  if and only if  $G$  maps to  $C_t^2$ , and we are done.

If  $t$  is odd, then  $C_t^2$  is not planar, the set of edges  $v_i v_{i+1}$  (resp.  $v_i v_{i+2}$ ) induces an odd cycle and there exists no automorphism of  $C_t^2$  that maps an edge  $v_i v_{i+1}$  to an edge  $v_i v_{i+2}$ . Consider the planar graph  $H$  obtained from  $C_t^2$  by removing the edge  $v_0 v_2$ . Notice that every homomorphism of  $H$  to  $C_t^2$  actually corresponds to an automorphism of  $C_t^2$ . We reduce PLANAR HOM( $C_t$ ) to PLANAR HOM( $C_t^2$ ). Let  $G$  be a planar graph and let  $G'$  be the planar graph obtained from  $G$  as follows. For every edge  $e$  of  $G$ , we add a copy of  $H$  and we identify the edge  $v_0 v_1$  of this copy of  $H$  with  $e$ . Again,  $G$  maps to  $C_t$  if and only if  $G'$  maps to  $C_t^2$  and we are done.

If  $t \equiv 0 \pmod 4$ , then both the set of edges  $v_i v_{i+1}$  and the set of edges  $v_i v_{i+2}$  induce a bipartite graph. Thus, the kind of reductions above does not work. We use instead a reduction similar to the one used for odd cycles in [33]. We reduce PLANAR HOM( $K_3$ ) (that is, PLANAR 3-COLOURING) to PLANAR HOM( $C_t^2$ ). Let us set  $t = 4k$ . Consider the graph  $H$  obtained from  $C_t^2$  by removing the edges  $v_{2k-1} v_{2k}$  and  $v_{2k} v_{2k+2}$ . Notice that every homomorphism of  $H$  to  $C_t^2$  that maps  $v_0$  to  $v_0$  also maps  $v_{2k}$  to either  $v_{2k-1}$ ,  $v_{2k}$ , or  $v_{2k+1}$ .

Let  $G$  be a planar graph and let  $G'$  be the planar graph obtained from a planar embedding of  $G$  as follows. For every face  $f$  of  $G$ , we first place a new vertex  $u_f$  inside the face  $f$ , and then for every vertex  $w$  of  $G$  incident to  $f$ , we add a copy of  $H$  and identify  $v_0$  with  $u_f$  and  $v_{2k}$  with  $w$ . Every vertex in the subgraph  $G$  of  $G'$  is said to be *old*. If  $G$  is 3-colourable, then we can map the subgraph  $G$  of  $G'$  to the triangle  $v_{2k-1} v_{2k} v_{2k+1}$  of  $C_t^2$ . Then we can extend this  $C_t^2$ -colouring to  $G'$  such that every vertex  $u_f$  of  $G'$  maps to  $v_0$ .

It remains to show that if  $G'$  maps to  $C_t^2$ , then  $G$  is 3-colourable. So we suppose for contradiction that there exists a planar graph  $G$  such that  $G'$  maps to  $C_t^2$  and  $G$  is not 3-colourable. Moreover, we choose such a graph  $G$  with the minimum number of vertices.

Let us first show that  $G$  is a planar triangulation. Suppose to the contrary that  $G$  contains a face  $f$  of length at least 4. Then  $G'$  has a  $C_t^2$ -colouring that maps  $u_f$  to  $v_0$ . So, every old vertex in  $G'$  that corresponds to a vertex incident with  $f$  in  $G$  is mapped to a vertex in  $\{v_{2k-1}, v_{2k}, v_{2k+1}\}$ . Since  $|f| \geq 4$ , two such old vertices  $x$  and  $y$  in  $G'$  get the same colour. Let  $H$  be the planar graph obtained from  $G$  by identifying  $x$  and  $y$  and removing multiple edges. Notice that  $H$  is not 3-colourable, whereas the graph  $H'$  obtained by applying our reduction to  $H$  maps to  $C_t^2$ . This contradicts the minimality of  $G$  and thus  $G$  is a planar triangulation.

Let  $w$  be any old vertex. Since  $G'$  maps to  $C_t^2$ , consider a  $C_t^2$ -colouring of  $G'$  that maps  $w$  to  $v_0$ . Then every old vertex adjacent to  $w$  maps to a vertex in  $S = \{v_{-2}, v_{-1}, v_1, v_2\}$ . Notice that  $S$  induces a path in  $C_t^2$ . Since  $G$  is a triangulation, the old vertices adjacent to  $w$  induce a cycle  $C$  which maps to  $S$ . So  $C$  maps to a bipartite graph and thus  $C$  is bipartite. This means that the length of  $C$  is even and thus that the degree of  $w$  in  $G$  is even. Thus, the degree of every vertex of  $G$  is even, that is,  $G$  is an Eulerian planar triangulation. This is a contradiction since every Eulerian planar triangulation is 3-colourable (see Exercise 9.6.2 in [3]).  $\square$

### 3.2. Cubic circular cliques

Recall that  $K_{4t/(2t-1)}$  is the circular clique with vertex set  $\{k_0, \dots, k_{4t-1}\}$  and such that  $k_i$  is adjacent to  $k_{i+2t-1}$ ,  $k_{i+2t}$ , and  $k_{i+2t+1}$  (indices being taken modulo  $4t$ ). We now use our result of Section 3.1 to show the following.

**Theorem 3.2.** For every  $t \geq 2$ , PLANAR HOM( $K_{4t/(2t-1)}$ ) is NP-complete.

**Proof.** We reduce PLANAR HOM( $C_{4t}^2$ ), which is NP-complete by Theorem 3.1, to PLANAR HOM( $K_{4t/(2t-1)}$ ). For this, consider the 1-edge-coloured indicator  $(C_{2t+1}, i, j)$  consisting of a cycle of length  $2t + 1$  on which  $i$  and  $j$  are at distance 2. Clearly, this indicator construction preserves planarity. Now, consider a homomorphism  $f$  from  $(C_{2t+1}, i, j)$  to  $K_{4t/(2t-1)}$ . By the symmetries of both graphs, we may assume that  $f(i) = k_a$  for some  $a \in \{0, \dots, 4k - 1\}$ . Note that the shortest odd cycles in  $K_{4t/(2t-1)}$  are of length  $2t + 1$ . Thus,  $(C_{2t+1}, i, j)$  must be mapped one-to-one. In fact, we must have  $f(j) \in \{k_{a-2}, k_{a-1}, k_{a+1}, k_{a+2}\}$  (where indices are taken modulo  $4t$ ). Thus, the graph  $K_{4t/(2t-1)}^*$  obtained from applying  $(C_{2t+1}, i, j)$  to  $K_{4t/(2t-1)}$  is isomorphic to  $C_{4t}^2$ , and by Theorem 2.5 the proof is complete.  $\square$

### 4. Unbalanced even cycles of length at least 6

We are now ready to prove that unbalanced even cycles of length at least 6 define an NP-complete s-homomorphism problem for planar graphs.

**Theorem 4.1.** For every  $k \geq 3$ , PLANAR s-HOM( $UC_{2k}$ ) is NP-complete.

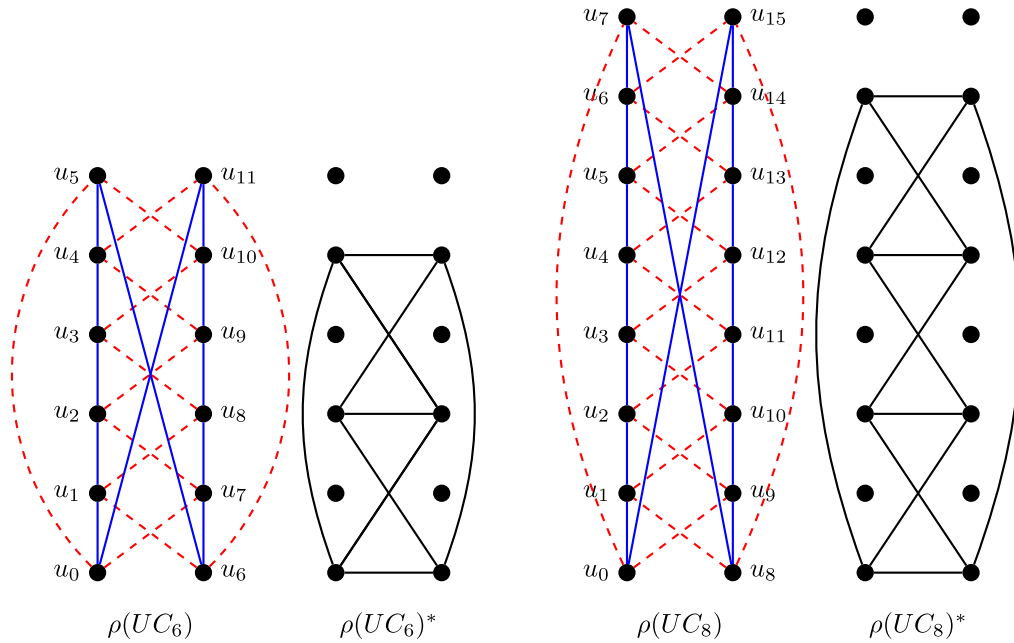

**Fig. 2.** The switching graphs  $\rho(UC_6)$  and  $\rho(UC_8)$ , and the undirected graphs  $\rho(UC_6)^*$  and  $\rho(UC_8)^*$  resulting from the application of the indicator  $(I, i, j)$  from Fig. 1 (in which we only draw one of the two isomorphic components). The core of  $\rho(UC_6)^*$  is  $K_3$  and the core of  $\rho(UC_8)^*$  is  $K_{8/3}$ , the Wagner graph.

**Proof.** We will equivalently show that  $\text{PLANAR HOM}(\rho(UC_{2k}))$  is NP-complete.

Let  $u_0, \dots, u_{4k-1}$  be the vertices of  $\rho(UC_{2k})$ . The positive edges of  $\rho(UC_{2k})$  are  $u_i u_{i+1}$  and the negative edges are  $u_i u_{i+2k-1}$ . Consider the indicator  $(I, i, j)$  of Fig. 1. Clearly, it preserves planarity. Now, consider a homomorphism  $f$  of  $(I, i, j)$  to  $\rho(UC_{2k})$ . By the symmetries of both graphs, we may assume that  $f(i) = u_a$  for some  $a \in \{0, \dots, 4k-1\}$ . Then, we must have  $f(j) \in \{u_{a+2k-2}, u_{a+2k}, u_{a+2k+2}\}$  (indices taken modulo  $4k$ ).

Thus, the graph  $\rho(UC_{2k})^*$  obtained from applying  $(I, i, j)$  to  $\rho(UC_{2k})$  is cubic. Notice that  $\rho(UC_{2k})$  is bipartite, and that  $(I, i, j)$  is bipartite too with  $i$  and  $j$  in the same part. It follows that  $\rho(UC_{2k})^*$  will consist of at least two connected components. See Fig. 2 for a picture when  $k = 3, 4$ . We now distinguish two cases to determine  $\rho(UC_{2k})^*$ .

*Case 1:  $k$  is odd.* In this case,  $\rho(UC_{2k})^*$  contains a copy of the cycle  $C_k = \{c_0, \dots, c_{k-1}\}$ , where  $c_0 = u_0$  and  $c_{i+1} = u_{i+2k+2}$  when  $i$  is even and  $c_{i+1} = u_{i-(2k-2)}$  when  $i$  is odd (thus,  $c_k = u_{2k-2}$ ). Furthermore, we claim that  $C_k$  is the core of  $\rho(UC_{2k})^*$ : indeed, consider the  $k$  sets of vertices  $U_j = \{u_j, \dots, u_{j+3}\}$  for  $j = 0 \pmod 4$  and  $0 \leq j < 4k$ . For  $u_i \in U_j$ , let  $f(u_i) = c_j$ :  $f$  is a homomorphism from  $\rho(UC_{2k})^*$  to its subgraph  $C_k$ .

*Case 2:  $k$  is even.* In this case, letting  $k = 2t$  with  $t \geq 2$ , we have that  $\rho(UC_{2k})^*$  consists of two copies of the circular clique  $K_{4t/(2t-1)}$ : one on vertex set  $\{u_i \mid i = 0 \pmod 2\}$  and the other on vertex set  $\{u_i \mid i = 1 \pmod 2\}$ . Thus, the core of  $\rho(UC_{2k})^*$  is  $K_{4t/(2t-1)}$ .

In both cases, we have  $\text{PLANAR HOM}(\rho(UC_{2k})^*)$  NP-complete: by [25,33] when  $k$  is odd and by Theorem 3.2 when  $k$  is even. We thus apply Theorem 2.5 to obtain a reduction from  $\text{PLANAR HOM}(\rho(UC_{2k})^*)$  to  $\text{PLANAR HOM}(\rho(UC_{2k}))$ : this completes the proof.  $\square$

**5. Unbalanced cycles of length 4**

The proof of Theorem 4.1 fails to show that  $\text{PLANAR HOM}(UC_4)$  is NP-complete since  $\rho(UC_4)^*$  is  $K_4$  and thus this would require  $\text{PLANAR HOM}(K_4)$  to be NP-complete, which is false by the Four Colour Theorem. However, we give an ad-hoc reduction in this section.

**Theorem 5.1.**  $\text{PLANAR S-HOM}(UC_4)$  is NP-complete.

As before, we show equivalently that  $\text{PLANAR HOM}(\rho(UC_4))$  is NP-complete. It is easy to see that  $\text{PLANAR HOM}(\rho(UC_4))$  is in NP. We thus focus on proving NP-hardness. Recall that  $\rho(UC_4)$  is the circulant graph with vertices  $u_0, \dots, u_7$ , positive edges  $u_i u_{i+1}$  and negative edges  $u_i u_{i+3}$  (it is depicted in Fig. 1, see also Fig. 3 for a symmetric drawing). We reduce  $\text{PLANAR HOM}(K_3)$  (that is,  $\text{PLANAR 3-COLOURING}$ ), which is NP-complete [20], to  $\text{PLANAR HOM}(\rho(UC_4))$ . In the following,  $G$  is an instance of  $\text{PLANAR HOM}(K_3)$ . Our goal is to construct a planar signed graph  $H$  such that  $G$  is 3-colourable if and only if  $H$  is a positive instance of  $\text{PLANAR HOM}(\rho(UC_4))$ . We assume that  $G$  is connected, otherwise, we apply our construction to each connected component.

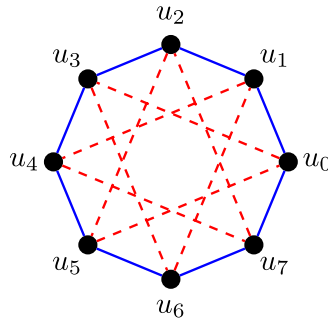

Fig. 3. The signed graph  $\rho(UC_4)$ .

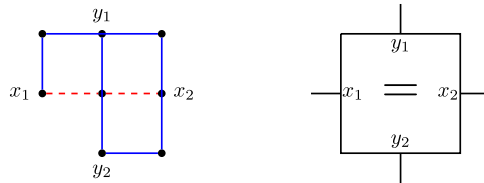

Fig. 4. Copy gadget and its schematic representation.

5.1. Outline of the reduction

We first present the generic ideas of our reduction. Note that the graph  $\rho(UC_4)$  is bipartite. Therefore,  $H$  will be bipartite, otherwise there is no homomorphism from  $H$  to  $\rho(UC_4)$ . In our construction of  $H$ , the important vertices belong to the same partite set. All of the vertices that will be named in our gadgets will always belong to that partite set. By the symmetry of  $\rho(UC_4)$ , we can assume that, in every homomorphism from one of our graphs to  $\rho(UC_4)$ , all of the named vertices will always be mapped to some  $u_i$  with  $i \equiv 0 \pmod 2$ .

For each vertex  $v$  of degree  $d$  in  $G$ , we will create a gadget  $G_v$  in  $H$  with  $2d$  special vertices  $v_0, \dots, v_{2d-1}$  (called ports) such that there is an embedding of that gadget in the plane where  $v_0, \dots, v_{2d-1}$  are on a facial trail in that order. We want that any homomorphism  $\varphi$  from  $H$  to  $\rho(UC_4)$  satisfies:

1.  $\varphi(v_0) \neq \varphi(v_1)$
2. for  $i = 0, 1, \dots, d-1$ ,  $\varphi(v_{2i+1}) = \varphi(v_{2i})$ .

We will describe later how to enforce these conditions. Assuming that they are satisfied, let  $\varphi$  be any homomorphism from  $H$  to  $\rho(UC_4)$ . Let  $\varphi(v_1) = u_l$  and  $\varphi(v_0) = u_k$ . The difference  $l - k \pmod 8$  will represent the colour of  $v$  in a valid 3-colouring of  $G$ . For the sake of readability, we identify  $u_k$  with its index  $k$ , so that we can read the colour of  $v$  by the operation  $\varphi(v_1) - \varphi(v_0) \pmod 8$ . We shall call  $\varphi(v_0)$  the ground of  $v$  and  $\varphi(v_1) - \varphi(v_0)$  its colour. Note that Condition 1 ensures that there are only three possible colours for  $v$ : 2, 4, and 6. Condition 2 asserts that the colour of  $v$  propagates  $d$  times throughout the vertex gadget as  $\varphi(v_{2i+1}) - \varphi(v_{2i}) \pmod 8, i \in \{0, \dots, d-1\}$ , allowing us to use any pair  $(v_{2i}, v_{2i+1})$  for retrieving it.

Recall that we want  $H$  to be a positive instance of  $\text{PLANAR HOM}(\rho(UC_4))$  if and only if  $G$  is 3-colourable. Therefore, we also want to ensure that any homomorphism  $H \rightarrow \rho(UC_4)$  assigns different colours to each pair of adjacent vertices in  $G$ . We thus construct  $H$  such that the following condition is satisfied:

3. For each homomorphism  $\varphi : H \rightarrow \rho(UC_4)$ , two adjacent vertices in  $G$  receive the same ground, and different colours.

Note that if we manage to construct  $H$  such that the three conditions hold, then it is easy to recover a proper 3-colouring of  $G$  from any homomorphism  $H \rightarrow \rho(UC_4)$ . In the following subsections, we describe our gadgets, and we prove that the previous conditions hold.

5.2. Construction of the gadgets

To build our vertex gadget, we need to start with several smaller gadgets. We start with a first construction allowing to make copies of a vertex that are mapped to the same image under any homomorphism, called copy gadget (see Fig. 4).

**Lemma 5.2.** *Let  $\varphi$  be a homomorphism from the copy gadget from Fig. 4 to  $\rho(UC_4)$ . Then,  $\varphi(x_1) = \varphi(x_2), \varphi(y_1) = \varphi(y_2)$  and  $\varphi(y_1) - \varphi(x_1) \in \{\pm 2\}$ .*



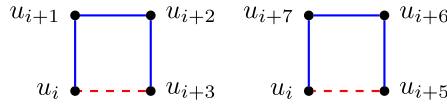

Fig. 5. The only possible homomorphisms for a copy of  $UC_4$ . The indices are taken modulo 8.

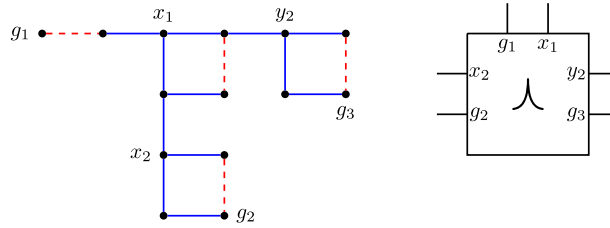

Fig. 6. Split gadget and its schematic representation.

Conversely, if we partially fix  $\varphi$  from  $\{x_1, x_2, y_1, y_2\}$  to  $\{u_0, u_2, u_4, u_6\}$  such that  $\varphi(x_1) = \varphi(x_2)$ ,  $\varphi(y_1) = \varphi(y_2)$  and  $\varphi(y_1) - \varphi(x_1) \in \{\pm 2\}$ , one can extend  $\varphi$  to a homomorphism from the copy gadget to  $\rho(UC_4)$ .

**Proof.** The first thing to notice is that in a homomorphism from a copy of  $UC_4$  to  $\rho(UC_4)$ , each vertex maps to a distinct vertex, and the only ways to do it are shown in Fig. 5.

Given the image of a vertex, there are two possibilities for the remainder of the copy of  $UC_4$ , and given the images of two vertices, there is at most one way to complete the homomorphism. In a homomorphism from the gadget to  $\rho(UC_4)$ , assume without loss of generality that  $x_1$  maps to  $u_0$ . The two possibilities to map the vertices of the copy of  $UC_4$  containing  $x_1$  lead to  $y_1$  being mapped either to  $u_2$  or  $u_6$ . Then, the mapping of the remainder of the vertices is forced, leading to  $x_2$  being mapped to  $u_0$  and  $y_2$  to the same vertex as  $y_1$ . The symmetries of  $UC_4$  complete the proof of the lemma.  $\square$

Given a vertex  $v$  in  $G$ , we want to use the copy gadget to ensure that Condition 2 holds in the vertex gadget  $G_v$ , by identifying  $x_1$  with  $v_{2i}$  and  $x_2$  with  $v_{2i+2}$  for  $i = 0, \dots, d - 1$  (indices are taken modulo  $2d$ ). However, we also need to have a copy of the ground between each  $x_i$ .

To this end, we have to design a crossing-type gadget. Observe that the copy gadget allows to cross two images as soon as they differ by  $\pm 2$ .

We thus need to find a gadget that can handle the case where the difference is 4. To this end, we introduce the *split gadget* from Fig. 6, which allows to encode a difference of  $\pm 2$  or  $\pm 4$  using two differences of  $\pm 2$ .

**Lemma 5.3.** Let  $\varphi$  be a homomorphism from the split gadget from Fig. 6 to  $\rho(UC_4)$  such that  $\varphi(g_1) = \varphi(g_2) = \varphi(g_3)$ .

Then,  $\varphi(x_2) - \varphi(g_2)$  and  $\varphi(y_2) - \varphi(g_3)$  lie in  $\{\pm 2\}$ . Moreover,  $\varphi(x_1) - \varphi(g_1) = 4$  if and only if  $\varphi(x_2) \neq \varphi(y_2)$ , and  $\varphi(x_1) - \varphi(g_1) \in \{\pm 2\}$  if and only if  $\varphi(x_2) = \varphi(y_2)$ .

Conversely, if we partially fix  $\varphi$  from  $\{x_2, y_2, x_1, g_1, g_2, g_3\}$  to  $\{u_0, u_2, u_4, u_6\}$  such that  $\varphi(g_1) = \varphi(g_2) = \varphi(g_3)$ ,  $\varphi(x_2) - \varphi(g_2)$  and  $\varphi(y_2) - \varphi(g_3)$  lie in  $\{\pm 2\}$ ,  $\varphi(x_1) - \varphi(g_1) = 4$  if and only if  $\varphi(x_2) \neq \varphi(y_2)$ , and  $\varphi(x_1) - \varphi(g_1) \in \{\pm 2\}$  if and only if  $\varphi(x_2) = \varphi(y_2) = \varphi(x_1)$ , then one can extend  $\varphi$  to a homomorphism from the split gadget to  $\rho(UC_4)$ .

**Proof.** Consider a homomorphism  $\varphi$  from the gadget to  $\rho(UC_4)$ . Say that  $g_1, g_2$ , and  $g_3$  are mapped to  $u_0$ . Similarly to the proof of Lemma 5.2,  $x_2$  and  $y_2$  can each only be mapped to  $u_2$  or  $u_6$ . Furthermore,  $x_1$  can only be mapped to  $u_2, u_4$  or  $u_6$ . Now, if  $x_1$  is mapped to  $u_4$ , then its two neighbours in its copy of  $UC_4$  are mapped one to  $u_3$  and one to  $u_5$ , forcing  $x_2$  and  $y_2$  to be mapped one to  $u_2$  and the other to  $u_6$ . If  $x_1$  is mapped to  $u_2$ , then its two neighbours in its copy of  $UC_4$  are mapped one to  $u_1$  and one to  $u_3$ , forcing  $x_2$  and  $y_2$  to be mapped either both to  $u_2$  or both to  $u_6$ . The case when  $x_1$  is mapped to  $u_6$  is similar. If  $g_1, g_2$ , and  $g_3$  are mapped to another  $u_i$ , then the symmetries of  $\rho(UC_4)$  yield the result.

To prove the converse, one can check that every time we specified that something was forced above, there actually existed a homomorphism that verified the conditions.  $\square$

Note that the split gadget can be used in two ways: for splitting an image in  $\{\pm 2, \pm 4\}$  into two images in  $\{\pm 2\}$ , but also “backwards” for combining two images in  $\{\pm 2\}$  into an image in  $\{\pm 2, \pm 4\}$ . Thus, by combining the copy gadget and the split gadget, we obtain our crossing gadget, that allows a crossing between two images that differ from  $\pm 2$  or  $\pm 4$ , see Fig. 7. It is clear that the result is planar. Notice that the six vertices towards the centre (the lower vertices of the upper split gadget, the upper vertices of the lower split gadget, the right vertex of the left copy gadget, and the left vertex of the right copy gadget) are all identified into one vertex.

**Lemma 5.4.** Let  $\varphi$  be a homomorphism from the crossing gadget depicted in Fig. 7 to  $\rho(UC_4)$ .

Then,  $\varphi(x_1) = \varphi(x_2)$ ,  $\varphi(y_1) = \varphi(y_2)$  and  $\varphi(y_1) - \varphi(x_1) \in \{\pm 2, \pm 4\}$ .

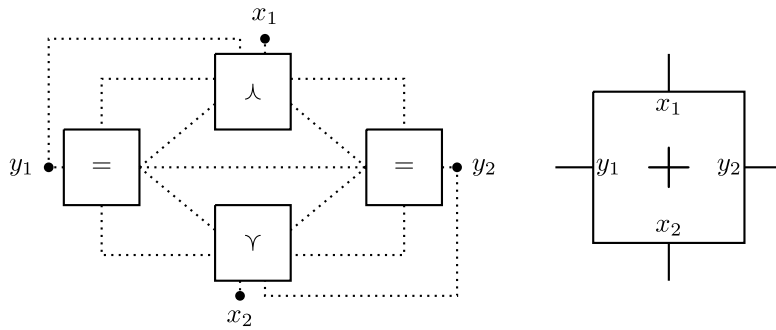

Fig. 7. Construction of the crossing gadget (dotted links mean identification of vertices) and its schematic representation.

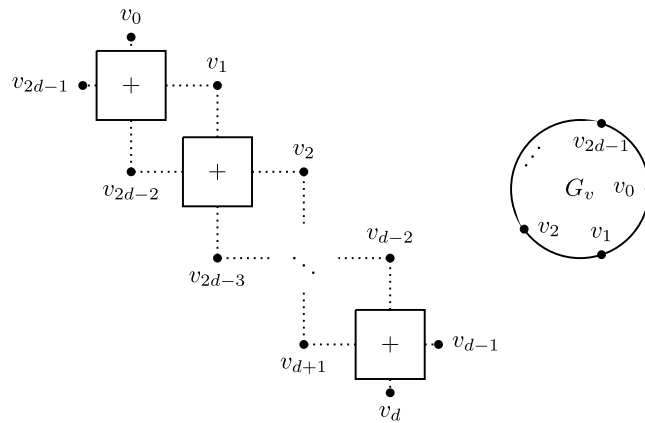

Fig. 8. Vertex gadget  $G_v$  (dotted links mean identification of vertices) and its schematic representation.

Conversely, if we partially fix  $\varphi$  from  $\{x_1, x_2, y_1, y_2\}$  to  $\{u_0, u_2, u_4, u_6\}$  such that  $\varphi(x_1) = \varphi(x_2)$ ,  $\varphi(y_1) = \varphi(y_2)$  and  $\varphi(y_1) - \varphi(x_1) \in \{\pm 2, \pm 4\}$ , then one can extend  $\varphi$  to a homomorphism from the crossing gadget to  $\rho(UC_4)$ .

**Proof.** The proof is a direct application of Lemmas 5.2 and 5.3. Consider a homomorphism from the gadget to  $\rho(UC_4)$ . The vertices  $y_1$  and  $y_2$  must be mapped to the same vertex due to the copy gadgets. Say  $y_1$  and  $y_2$  are mapped to  $u_0$ . Notice that in addition, due to the copy gadgets and the identifications of vertices, all vertices of type  $g_i$  from the two split gadgets are mapped to  $u_0$  as well. Thus, Lemma 5.3 can be applied to the two split gadgets.

By Lemma 5.3,  $x_1$  is mapped to  $u_2, u_4$ , or  $u_6$ . If  $x_1$  is mapped to  $u_2$  or  $u_6$  (say,  $u_2$ ), then by Lemma 5.3, the remaining two labelled vertices (other than the  $g_i$ 's) of the upper split gadget are also mapped to  $u_2$ . So are their “copies” in the two copy gadgets, and by applying Lemma 5.3 to the lower split gadget, so is  $x_2$ , as desired.

If  $x_1$  is mapped to  $u_4$ , then by Lemma 5.3 the remaining two vertices of the split gadget are mapped one to  $u_2$  and one to  $u_6$ ; thus, again, so are their copies in the copy gadgets, and thus again by Lemma 5.3  $x_2$  is mapped to  $u_4$ .

The existence of a homomorphism extending any good mapping of  $x_1, x_2, y_1$ , and  $y_2$  to  $\{u_0, u_2, u_4, u_6\}$  can be checked similarly.  $\square$

The whole vertex gadget is now created by gluing crossing gadgets, as shown in Fig. 8. Due to Lemma 5.4, we obtain that Conditions 1 and 2 are satisfied.

We use again the crossing gadget to define the edge gadget. For each edge  $vw$  of  $G$ , we link two pairs  $(v_{2i}, v_{2i+1})$  and  $(w_{2j}, w_{2j+1})$  of consecutive ports of the vertex gadgets  $G_v$  and  $G_w$  by identifying  $v_{2i}, v_{2i+1}, w_{2j}$  with  $x_1, y_1, x_2$ , and adding an alternating path of length 2 between  $y_2$  and  $w_{2j+1}$  as shown in Fig. 9.

Due to this construction, any homomorphism  $H \rightarrow \rho(UC_4)$  must map the bottom vertex ( $x_2$ ) from the crossing gadget and  $w_{2j+1}$  to different images, with a difference in  $\{\pm 2, \pm 4\}$ . Thus, Lemma 5.4 also ensures that Condition 3 holds since any homomorphism maps  $v_{2i+1}$  and  $w_{2j+1}$  to the same image (the ground) and  $v_{2i}$  and  $w_{2j}$  to different ones (their colours).

To ensure that this construction outputs a planar graph  $H$ , we first fix a planar embedding of  $G$ . Then, we use the ports of the gadgets associated to  $v$  in the same cyclic ordering as the edges incident to  $v$  in  $G$ .

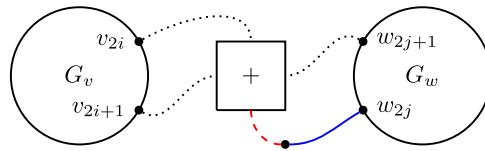

Fig. 9. Edge gadget (dotted links mean identification of vertices).

5.3. End of the proof

As we already saw, our three conditions are satisfied by  $H$ , hence if there is a homomorphism  $H \rightarrow \rho(UC_4)$ , then  $G$  is 3-colourable. Conversely, given a 3-colouring of  $G$ , we can define a homomorphism  $\varphi : H \rightarrow \rho(UC_4)$ . Given a vertex  $v$  of  $G$  with colour  $c \in \{1, 2, 3\}$ , we define  $\varphi(v_{2i}) = u_0$  and  $\varphi(v_{2i+1}) = u_{2c}$ . We can then extend this partial homomorphism to each crossing gadget. Therefore, we obtain a reduction. Since  $H$  can be constructed in polynomial time, we finally obtain that  $\text{PLANAR HOM}(\rho(UC_4))$  (and thus,  $\text{PLANAR s-HOM}(UC_4)$ ) is NP-hard.

6. Planar graphs with large girth

In this section, we prove a “hypothetical complexity” type theorem for  $s$ -homomorphisms to unbalanced even cycles, similar to the one in [13] for  $\text{PLANAR HOM}(C_{2k+1})$ . This is motivated by the signed graph analogue of Jaeger’s conjecture: it is conjectured in [39] that every planar bipartite signed graph of girth at least  $4k - 2$  has an  $s$ -homomorphism to  $UC_{2k}$  (see [12] for recent progress).

**Theorem 6.1.** *Let  $g \geq 4$  and  $k \geq 2$  be fixed integers. Either every bipartite planar signed graph with girth at least  $g$  has an  $s$ -homomorphism to  $UC_{2k}$ , or  $\text{PLANAR s-HOM}(UC_{2k})$  is NP-complete for planar signed graphs with girth at least  $g$ .*

**Proof.** Note that by Proposition 2.2 and Corollary 2.3, the statement is equivalent to the one stating that every bipartite planar signed graph with girth at least  $g$  has a homomorphism to  $\rho(UC_{2k})$ , or  $\text{PLANAR HOM}(\rho(UC_{2k}))$  is NP-complete for planar signed graphs with girth at least  $g$ .

Suppose that  $H$  is a bipartite planar graph with girth at least  $g$  that does not map to  $\rho(UC_{2k})$  and that  $H$  is minimal with respect to the subgraph order. Let  $xy$  be a positive edge of  $H$ . By minimality,  $H \setminus xy$  is  $\rho(UC_{2k})$ -colourable. Let  $i$  be the smallest integer such that there exists a homomorphism that maps  $x$  to  $u_0$  and  $y$  to  $u_i$ . So  $i$  is odd and  $3 \leq i \leq 2k - 1$ . Let  $J$  be the graph obtained from  $H \setminus xy$  by adding a path  $x = x_0, x_1, \dots, x_{i-1}, x_i = y$  of  $i$  positive edges between  $x$  and  $y$ . So  $J$  is  $\rho(UC_{2k})$ -colourable and since  $\rho(UC_{2k})$  is edge-transitive, we can assume that  $x_0$  maps to  $u_0$  and  $x_1$  maps to  $u_1$ . Then by minimality of  $i$ ,  $x_j$  maps to  $u_j$  for every  $0 \leq j \leq i$  and we call this a canonical colouring. Now we consider the graph  $J'$  obtained from two copies  $J_1$  and  $J_2$  of  $J$  by identifying the vertices  $x_{i-1}$  (resp.  $x_i$ ) of both copies. If a canonical colouring of the subgraph  $J_1$  is extended to  $J'$ , then both vertices  $x_0$  map to  $u_0$ . Thus, every  $\rho(UC_{2k})$ -colouring of  $J'$  maps both vertices  $x_0$  to the same vertex. Notice that the distance between the two vertices  $x_0$  is  $2i - 2 \geq 4$ .

Then, every instance  $G$  of  $\text{PLANAR HOM}(\rho(UC_{2k}))$  can be transformed into an equivalent instance  $G'$  of  $\text{PLANAR HOM}(\rho(UC_{2k}))$  with girth at least  $g$  using, as a vertex gadget, sufficiently many copies of the gadget  $J'$ . □

7. Restricting the maximum degree

We now consider instance restrictions according to the maximum degree. It is proved in [18] that  $\text{HOM}(C_{2k+1})$  can be reduced to  $\text{HOM}(C_{2k+1})$  for subcubic graphs using a gadget consisting of a sequence of copies of  $C_{2k+1}$  glued to each other. Furthermore, this reduction preserves the planarity, thus it follows from [25,33] that  $\text{PLANAR HOM}(C_{2k+1})$  is NP-complete for subcubic graphs. Here, we show an analogue of this result for  $s$ -homomorphisms to unbalanced even cycles.

**Theorem 7.1.**  *$\text{PLANAR s-HOM}(UC_4)$  remains NP-complete for signed graphs with maximum degree 4. For every  $k \geq 3$ ,  $\text{PLANAR s-HOM}(UC_{2k})$  remains NP-complete for subcubic signed graphs (of girth  $2k$ ).*

**Proof.** In both cases, we reduce  $\text{PLANAR s-HOM}(UC_{2k})$  itself to  $\text{PLANAR s-HOM}(UC_{2k})$  on graphs with maximum degree  $\Delta = 3$  or 4 using a vertex-gadget with appropriate vertex degrees that forces the same colour (say colour 0) on arbitrarily many vertices of degree  $\Delta - 1$ . Our gadgets are similar to the ones from [18] for  $\text{PLANAR HOM}(C_{2k+1})$ , and are depicted in Fig. 10. For the reduction, each vertex  $v$  of degree  $d$  of the input graph is replaced by a copy  $G_v$  of this gadget containing  $2d$  glued cycles, and if  $v$  and  $w$  are adjacent, we add an edge between a vertex of  $G_v$  and a vertex of  $G_w$  that are labelled 0 in Fig. 10. Since the gadgets have girth  $2k$  and by Theorem 6.1,  $\text{PLANAR s-HOM}(UC_{2k})$  is NP-complete for inputs of girth  $2k$ , our construction produces inputs of girth  $2k$ .

Observe that this approach does not work for  $\text{PLANAR s-HOM}(UC_4)$  on subcubic graphs: vertices coloured with 0 in the corresponding gadget have degree 3, not 2. □

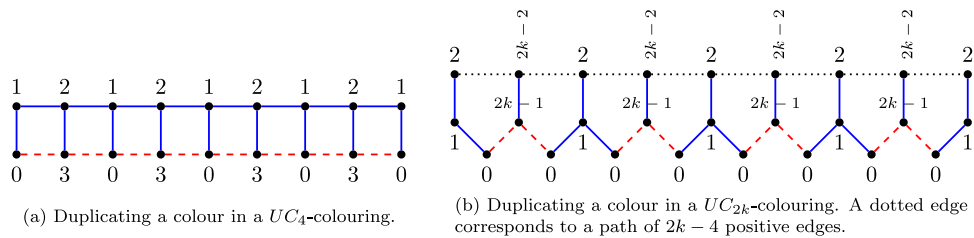

Fig. 10. Gadgets with vertices of degree 3 or 2, that are mapped to the same vertex in a  $UC_{2k}$ -colouring.

## 8. Concluding remarks

It would be interesting to settle the complexities of  $s\text{-HOM}(UC_4)$  and  $\text{PLANAR } s\text{-HOM}(UC_4)$  for graphs of maximum degree 3. Studying  $\text{PLANAR } s\text{-HOM}(H)$  for further classes of signed graphs  $H$  is also of interest. As  $\text{PLANAR } \text{HOM}(H)$  is connected to studies on homomorphism bounds for planar graphs [25,37,40],  $\text{PLANAR } s\text{-HOM}(H)$  is connected to the signed counterparts of these works, see for example [2,38].

When it comes to non-signed graphs, combined results of Moser [35] and Zhu [49] show that for every rational  $q$  such that  $2 \leq q \leq 4$ , there exists a planar graph with circular chromatic number  $q$ . The problem of deciding whether the circular chromatic number of a planar graph is at most  $q$  is NP-complete if  $q$  is equal to:

- $3 + \frac{1}{2}$ , by Theorem 3.1 since  $C_7^2 = \overline{C_7} = K_{7/2}$ .
- $2 + \frac{1}{t}$  for every  $t \geq 1$  by [25,33]
- $2 + \frac{2}{2t-1}$  for every  $t \geq 2$ , by Theorem 3.2.

It would be nice to extend these results to every rational  $q$  with  $2 < q < 4$ .

## CRedit authorship contribution statement

**François Dross:** Conceptualization, Data curation, Formal analysis, Funding acquisition, Investigation, Methodology, Project administration, Resources, Software, Supervision, Validation, Visualization, Writing - original draft, Writing - review & editing. **Florent Foucaud:** Conceptualization, Data curation, Formal analysis, Funding acquisition, Investigation, Methodology, Project administration, Resources, Software, Supervision, Validation, Visualization, Writing - original draft, Writing - review & editing. **Valia Mitsou:** Conceptualization, Data curation, Formal analysis, Funding acquisition, Investigation, Methodology, Project administration, Resources, Software, Supervision, Validation, Visualization, Writing - original draft, Writing - review & editing. **Pascal Ochem:** Conceptualization, Data curation, Formal analysis, Funding acquisition, Investigation, Methodology, Project administration, Resources, Software, Supervision, Validation, Visualization, Writing - original draft, Writing - review & editing. **Théo Pierron:** Conceptualization, Data curation, Formal analysis, Funding acquisition, Investigation, Methodology, Project administration, Resources, Software, Supervision, Validation, Visualization, Writing - original draft, Writing - review & editing.

## References

- [1] N. Alon, T.H. Marshall, Homomorphisms of edge-colored graphs and Coxeter groups, *J. Algebraic Combin.* 8 (1) (1998) 5–13.
- [2] L. Beaudou, F. Foucaud, R. Naserasr, Homomorphism bounds of signed bipartite  $K_4$ -minor-free graphs and edge-colourings of  $2k$ -regular  $K_4$ -minor-free multigraphs, *Discrete Appl. Math.* 261 (2019) 40–51.
- [3] A. Bondy, U. Murty, *Graph Theory with Applications*, American Elsevier Publishing Company, Inc, New York, 1976.
- [4] O.V. Borodin, S.J. Kim, A.V. Kostochka, D.B. West, Homomorphisms from sparse graphs with large girth, *J. Combin. Theory Ser. B* 90 (2004) 147–159.
- [5] R.C. Brewster, *Vertex colourings of edge-coloured graphs* (Ph.D. thesis), Simon Fraser University, Canada, 1993.
- [6] R.C. Brewster, The complexity of colouring symmetric relational systems, *Discrete Appl. Math.* 49 (1–3) (1994) 95–105.
- [7] R.C. Brewster, F. Foucaud, P. Hell, R. Naserasr, The complexity of signed graph and edge-coloured graph homomorphisms, *Discrete Math.* 340 (2) (2017) 223–235.
- [8] R.C. Brewster, T. Graves, Edge-switching homomorphisms of edge-coloured graphs, *Discrete Math.* 309 (18) (2009) 5540–5546.
- [9] R.C. Brewster, P. Hell, On homomorphisms to edge-coloured cycles, *Electron. Notes Discrete Math.* 5 (2009) 46–49.
- [10] R.C. Brewster, M.H. Siggers, A complexity dichotomy for signed  $H$ -colouring, *Discrete Math.* 341 (10) (2018) 2768–2773.
- [11] A.A. Bulatov, A dichotomy theorem for nonuniform CSPs, in: *Proceedings of the 58th IEEE Annual Symposium on Foundations of Computer Science, FOCS 2017*, IEEE Computer Society, 2017, pp. 319–330.
- [12] C. Charpentier, R. Naserasr, É. Sopena, Homomorphisms of sparse signed graphs. *Electron. J. Combin.*, accepted. [http://www.labri.fr/perso/sopena/pmwiki/uploads/Publications/mapping\\_to\\_UC2g\\_submitted.pdf](http://www.labri.fr/perso/sopena/pmwiki/uploads/Publications/mapping_to_UC2g_submitted.pdf).
- [13] L. Esperet, M. Montassier, P. Ochem, A. Pinlou, A complexity dichotomy for the coloring of sparse graphs, *J. Graph Theory* 73 (2012) 85–102.
- [14] T. Feder, C. Subi. On Barnette’s conjecture, Manuscript, 2006. <https://ecc.weizmann.ac.il/report/2006/015/>.
- [15] T. Feder, M.Y. Vardi, The computational structure of monotone monadic SNP and constraint satisfaction: a study through datalog and group theory, *SIAM J. Comput.* 28 (1) (1998) 57–104.

- [16] F. Foucaud, R. Naserasr, The complexity of homomorphisms of signed graphs and signed constraint satisfaction, in: Proceedings of the 11th Latin American Symposium on Theoretical Informatics 2014, LATIN 2014, in: Lecture Notes in Computer Science, vol. 8392, 2014, pp. 526–537.
- [17] A. Galluccio, L. Goddyn, P. Hell, High-girth graphs avoiding a minor are nearly bipartite, *J. Combin. Theory Ser. B* 83 (1) (2001) 1–14.
- [18] A. Galluccio, P. Hell, J. Nešetřil, The complexity of  $H$ -coloring of bounded degree graphs, *Discrete Math.* 222 (1–3) (2000) 101–109.
- [19] M.R. Garey, D.S. Johnson, *Computers and Intractability: A Guide to the Theory of NP-completeness*, W. H. Freeman, 1979.
- [20] M.R. Garey, D.S. Johnson, L.J. Stockmeyer, Some simplified NP-complete graph problems, *Theoret. Comput. Sci.* 1 (3) (1976) 237–267.
- [21] B. Guenin, Packing T-joins and edge-colouring in planar graphs, *Math. Oper. Res.* (in press).
- [22] B. Guenin, Packing odd circuit covers: a conjecture. Manuscript, 2005.
- [23] F. Harary, On the notion of balance of a signed graph, *Michigan Math. J.* 2 (2) (1953–1954) 143–146.
- [24] P. Hell, A. Kostochka, A. Raspaud, É. Sopena, On nice graphs, *Discrete Math.* 234 (1–3) (2001) 39–51.
- [25] P. Hell, R. Naserasr, C. Tardif, Complexity of planar homomorphisms. Manuscript, 2006.
- [26] P. Hell, J. Nešetřil, On the complexity of  $H$ -coloring, *J. Combin. Theory Ser. B* 48 (1) (1990) 92–110.
- [27] P. Hell, J. Nešetřil, *Graphs and Homomorphisms*, in: Oxford Lecture Series in Mathematics and Its Applications, Oxford University Press, 2004.
- [28] F. Jaeger, Nowhere-zero flow problems, in: *Selected Topics in Graph Theory*, vol. 3, Academic Press, New York, 1988, pp. 71–96.
- [29] R.M. Karp, Reducibility among combinatorial problems, in: R.E. Miller, J.W. Thatcher (Eds.), *Complexity of Computer Computations*, Plenum, New York, 1972, pp. 85–103.
- [30] W. Klostermeyer, G. MacGillivray, Homomorphisms and oriented colorings of equivalence classes of oriented graphs, *Discrete Math.* 274 (1–3) (2004) 161–172.
- [31] M. Kochol, Hypothetical complexity of the nowhere-zero 5-flow problem, *J. Graph Theory* 28 (1) (1998) 1–11.
- [32] D. König, *Theorie der endlichen und unendlichen Graphen*, Akademische Verlagsgesellschaft, Leipzig, 1936.
- [33] G. MacGillivray, M.H. Siggers, On the complexity of  $H$ -colouring planar graphs, *Discrete Math.* 309 (18) (2009) 5729–5738.
- [34] A. Montejano, P. Ochem, A. Pinlou, A. Raspaud, É. Sopena, Homomorphisms of 2-edge-colored graphs, *Discrete Appl. Math.* 158 (12) (2010) 1365–1379.
- [35] D. Moser, The star-chromatic number of planar graphs, *J. Graph Theory* 24 (1) (1997) 33–43.
- [36] N. Movarraei, P. Ochem, Oriented, 2-edge-colored, and 2-vertex-colored homomorphisms, *Inform. Process. Lett.* 123 (2017) 42–46.
- [37] R. Naserasr, Homomorphisms and edge-coloring of planar graphs, *J. Combin. Theory Ser. B* 97 (3) (2007) 394–400.
- [38] R. Naserasr, E. Rollová, É. Sopena, Homomorphisms of planar signed graphs to signed projective cubes, *Discrete Math. Theor. Comput. Sci.* 15 (3) (2013) 1–12.
- [39] R. Naserasr, E. Rollová, É. Sopena, Homomorphisms of signed graphs, *J. Graph Theory* 79 (3) (2015) 178–212.
- [40] J. Nešetřil, P. Ossona de Mendez, Tree-depth, Subgraph colorings and homomorphism bounds, *European J. Combin.* 27 (6) (2006) 1022–1041.
- [41] P. Ochem, A. Pinlou, S. Sen, Homomorphisms of 2-edge-colored triangle-free planar graphs, *J. Graph Theory* 85 (1) (2017) 258–277.
- [42] M.H. Siggers, Dichotomy for bounded degree  $H$ -colouring, *Discrete Appl. Math.* 157 (2009) 201–210.
- [43] T. Zaslavsky, A mathematical bibliography of signed and gain graphs and allied areas, *Electron. J. Combin., Dynamic Surveys in Combinatorics*, #DS8.
- [44] T. Zaslavsky, Characterizations of signed graphs, *J. Graph Theory* 5 (4) (1981) 401–406.
- [45] T. Zaslavsky, Chromatic invariants of signed graph, *Discrete Math.* 42 (2–3) (1982) 287–312.
- [46] T. Zaslavsky, Signed graph coloring, *Discrete Math.* 39 (2) (1982) 215–228.
- [47] T. Zaslavsky, Signed graphs, *Discrete Appl. Math.* 4 (1) (1982) 47–74.
- [48] T. Zaslavsky, How colorful the signed graph?, *Discrete Math.* 52 (2–3) (1984) 279–284.
- [49] X. Zhu, Planar graphs with circular chromatic numbers between 3 and 4, *J. Combin. Theory Ser. B* 76 (2) (1999) 170–200.
- [50] D. Zhuk, A proof of CSP dichotomy conjecture, in: Proceedings of the 58th IEEE Annual Symposium on Foundations of Computer Science, FOCS 2017, IEEE Computer Society, 2017, pp. 331–342.